

Linear

TIMI Asymmetric AS30 (30W) Fixture Guide

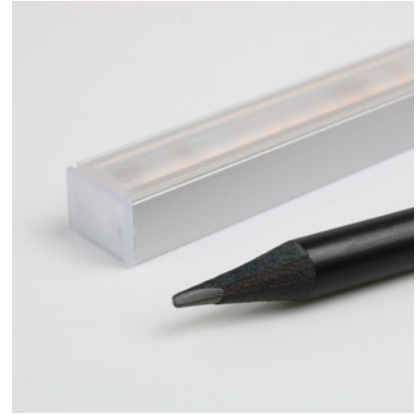

Indoor | Surface | Output up to 3630lm/m (853lm/ft)

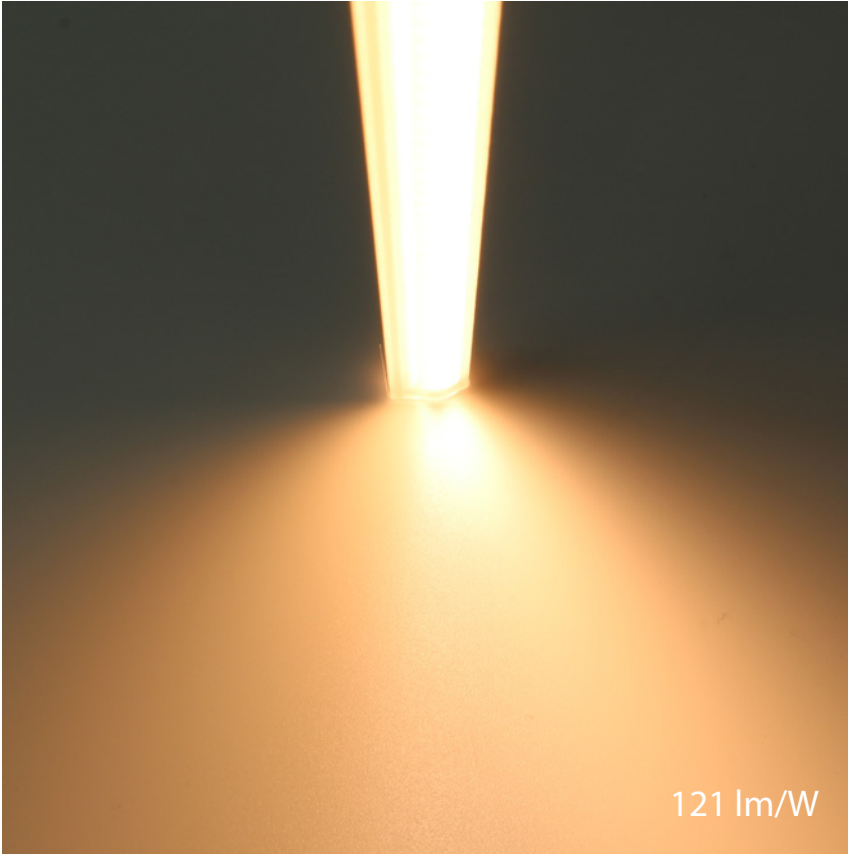

Key applications

- ✓ Architectural detail
- ✓ Backlighting & signage
- ✓ Cabinet & furniture
- ✓ Ceiling
- ✓ Cove lighting
- ✓ Direct lighting
- ✓ Display case
- ✓ Interior
- ✓ Retail display
- ✓ Shelving display
- ✓ Wallwashing

Key features

- ✓ A-line (High Efficacy)
- ✓ Asymmetric lens
- ✓ Custom lengths
- ✓ Constant Voltage (CV)
- ✓ High lumen efficacy
- ✓ IP40 dry area

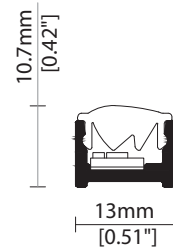

MOUNTING METHODS



TF Tape fixing



MF Magnet fixing

Linear

TIMI Asymmetric AS30 (30W)

Specification sheet



| | |
|-----------------------|--|
| Dimensions | H10.7/W13/L89-1012mm (H0.42/W0.51/L3.50-39.84in) *KKLN-A2 = 1010mm/39.76in Max |
| PCB Cut-point | 38.46mm increment/1000mm max (1.51in increment/39.37in max) |
| LED Pitch | 4.8mm - 208LED/m (0.19in - 64LED/ft) |
| Chip | A-line |
| Cover/Optics | KKLN-A2 Asymmetric lens (Beam tilt 15°, Beam angle 45°) |
| CCT | A-line: 2700K/3000K/4000K |
| LED binning | A-line: 3-step MacAdam ellipse |
| CRI | 94 |
| Lifetime | 50,000 hours @ 25°C (50,000 hours @ 77°F) |
| Operating temp | T _a = -25 to 45°C (T _c max = 80.1°C) T _a = -13 to 113°F (T _c max = 176°F) |
| IP Rating | IP40 |
| Finish | Silver anodised |
| Mounting | Surface mounting via 3M tape or magnet |
| Power feed | Hardwire tails or male/female connectors |
| Control | 0-10V/1-10V/DMX/DALI |



LED Grading Key

Exclusive Grade *KKDC tuned CCT range
A-line* 3-step CCT range
 KKDC highest lumen efficacy LED

| | | |
|--------------------------|-----------------------|-----------------------|
| Power consumption | Supply voltage | Supply current |
| 30W/m (9.14W/ft) | 24V DC | 1.25A/m (0.381A/ft) |

Performance Data (3000K)

| | | | | | | | | | | | | | | | | |
|---------------|--------------------------------|----|----|----|----|----|----|----|----|-----|-----|-----|------------|-----------|-----------|-----------|
| | R1 | R2 | R3 | R4 | R5 | R6 | R7 | R8 | R9 | R10 | R11 | R12 | R13 | R14 | | |
| A-line | 95 | 96 | 96 | 94 | 93 | 94 | 94 | 87 | 70 | 90 | 94 | 77 | 95 | 97 | | |
| | KKLN-A2 | | | | | | | | | | | | | | | |
| | | | | | | | | | | | | | CRI | R9 | Rf | Rg |
| A-line | 3630lm/m (853lm/ft) 121lm/w | | | | | | | | | | | | 94 | 70 | - | - |

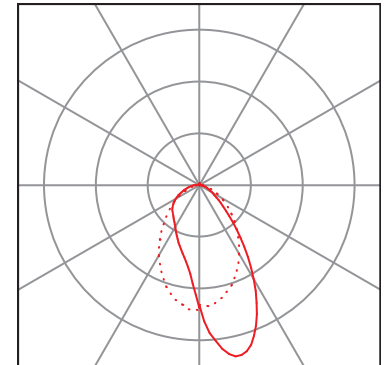
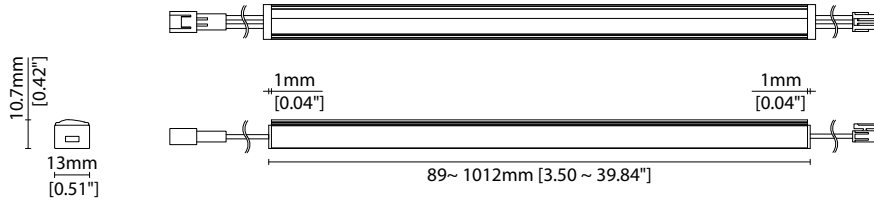

KKLN-A2 Asymmetric Lens
 — C0 / C180 cd / 1000 lm - - - C90 / C270

Data derived from independent UKAS/IESNA LM-79-08 accredited testing of production samples.

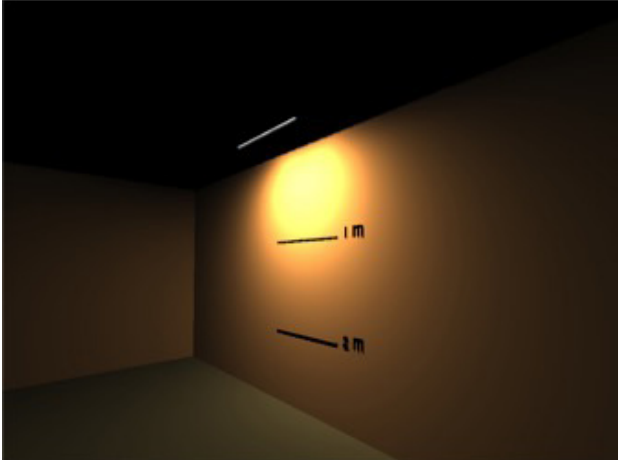

0.5M between light and wall

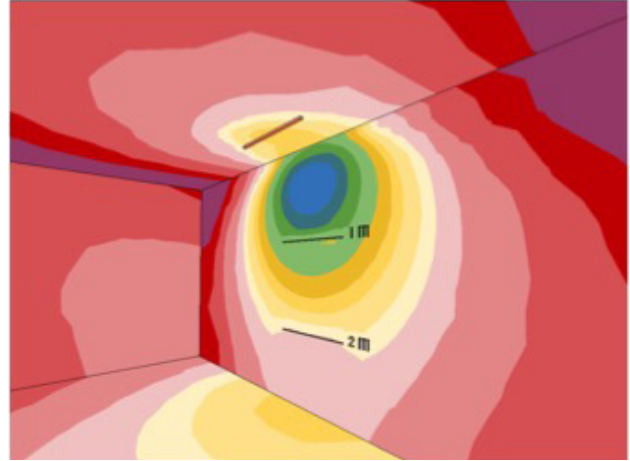

0.5M between light and wall (Psuedo color)

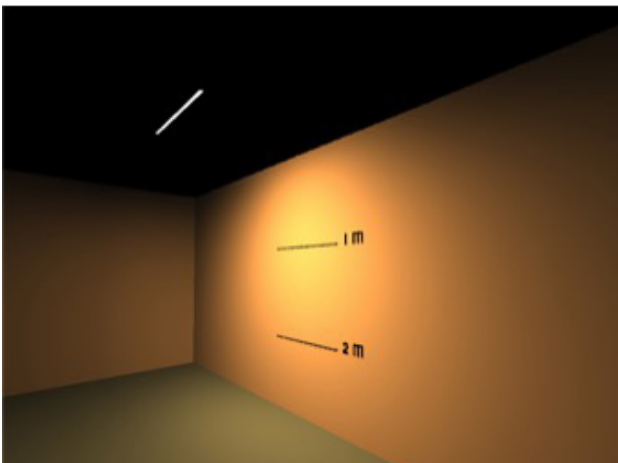

1M between light and wall

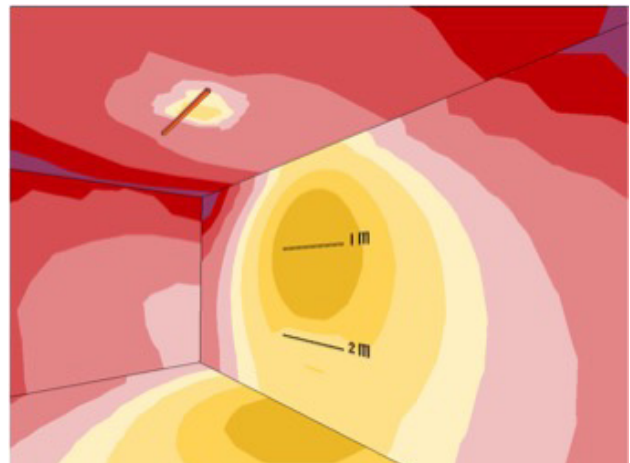

1M between light and wall (Psuedo color)

| Distance between wall and light | Light reaching height (based on wall) |
|---------------------------------|---------------------------------------|
| 0.5M | 1M |
| 1.1M | 1.5M |
| 1.3M | 2M |

Linear

TIMI Asymmetric AS30 (30W) Code Table



FIXTURE

| Model | Finish | Cover/Lens ¹ | Grade ² | LED | Colour (CCT) | Length Availability ³ | IP | Cable Length | Power Feed ⁴ | Fixing | Input |
|-----------------|----------------------|------------------------------|--------------------|--------|----------------------------------|---|---------|----------------------|--|-------------------------------------|----------|
| TIMI Asymmetric | Y Silver Anodised SA | KKLN-A2 (Asymmetric lens) A2 | A- | A AS30 | 2700K 27 3000K 30 4000K 40 | m 89-1012mm 38.46mm increments i 3.50-39.84in 1.51in increments (Specify length code OR total run length) | IP40 40 | 300mm (11.81in) 0300 | Single no sheath tail S00X Double no sheath tail D00X Single no sheath IP20 connector S20X Double no sheath IP20 connector D20X | 3M Tape fixed TF Magnet fixed MF | DC 24V g |

¹ Refer to **Cover/Lens Options** on **Options** pages ² Refer to **LED Grading Key** on **Specification sheet** page ³ Refer to **Length Availability List** or enter total run length instead of length code

⁴ Refer to **Power Feed Options** on **Options** pages

Code Example:

| | | | | | | | | | | | | | | | | | | | | | | | |
|------|---|-----------------|---|---------------------------|---|----|---|------|---|-------|---|-------|-----|------|----|-----------------|------|---------------------------------|------|---------------|----|--------|---|
| Y | - | SA | - | A2 | - | A | - | AS30 | - | 30 | - | m | 512 | - | 40 | - | 0300 | - | D20X | - | TF | - | g |
| TIMI | | Silver Anodised | | KKLN-A2 (Asymmetric lens) | | A- | | AS30 | | 3000K | | 512mm | | IP40 | | 300mm (11.81in) | | Double no sheath IP20 connector | | 3M Tape fixed | | DC 24V | |

ACCESSORIES

Connection Accessories

| | |
|---------|--|
| KKCN-01 | 2 PIN male & female 50mm (1.97in) pair |
| KKCN-03 | 2 PIN male & female 300mm (11.81in) pair |
| KKCN-06 | 2 PIN 300mm (11.81in) extension lead |

PSU/Driver

| |
|--|
| 0-10V/1-10W/DALI/DMX |
| * Refer to Driver/PSU Options page for details or provide requirement and KKDC to offer the suitable option |

* Refer to **Power feed** on **Accessories** pages

TIMI Asymmetric AS30 (30W)

Length Availability List



| Length Code | | Fixture Length ¹ | | LED Strip ² | | End Cap Dimension | | Wattage (W) | Output (lm) |
|-------------|--------------|-----------------------------|--------------|------------------------|--------------|-------------------|--------------|-------------|-------------|
| Metric | Imperial(US) | Metric | Imperial(US) | Metric | Imperial(US) | Metric | Imperial(US) | | |
| m0089 | i0004 | 89mm | 3.50in | 77mm | 3.03in | 2mm | 0.08in | 2.31 | 279 |
| m0127 | i0005 | 127mm | 5.02in | 115mm | 4.54in | 2mm | 0.08in | 3.46 | 419 |
| m0166 | i0007 | 166mm | 6.53in | 154mm | 6.06in | 2mm | 0.08in | 4.62 | 558 |
| m0204 | i0008 | 204mm | 8.04in | 192mm | 7.57in | 2mm | 0.08in | 5.77 | 698 |
| m0243 | i0010 | 243mm | 9.56in | 231mm | 9.09in | 2mm | 0.08in | 6.92 | 838 |
| m0281 | i0011 | 281mm | 11.07in | 269mm | 10.60in | 2mm | 0.08in | 8.08 | 977 |
| m0320 | i0013 | 320mm | 12.59in | 308mm | 12.11in | 2mm | 0.08in | 9.23 | 1117 |
| m0358 | i0014 | 358mm | 14.10in | 346mm | 13.63in | 2mm | 0.08in | 10.38 | 1257 |
| m0397 | i0016 | 397mm | 15.61in | 385mm | 15.14in | 2mm | 0.08in | 11.54 | 1396 |
| m0435 | i0017 | 435mm | 17.13in | 423mm | 16.66in | 2mm | 0.08in | 12.69 | 1536 |
| m0474 | i0019 | 474mm | 18.64in | 462mm | 18.17in | 2mm | 0.08in | 13.85 | 1675 |
| m0512 | i0020 | 512mm | 20.16in | 500mm | 19.69in | 2mm | 0.08in | 15.00 | 1815 |
| m0550 | i0022 | 550mm | 21.67in | 538mm | 21.20in | 2mm | 0.08in | 16.15 | 1955 |
| m0589 | i0023 | 589mm | 23.19in | 577mm | 22.71in | 2mm | 0.08in | 17.31 | 2094 |
| m0627 | i0025 | 627mm | 24.70in | 615mm | 24.23in | 2mm | 0.08in | 18.46 | 2234 |
| m0666 | i0026 | 666mm | 26.21in | 654mm | 25.74in | 2mm | 0.08in | 19.62 | 2373 |
| m0704 | i0028 | 704mm | 27.73in | 692mm | 27.26in | 2mm | 0.08in | 20.77 | 2513 |
| m0743 | i0029 | 743mm | 29.24in | 731mm | 28.77in | 2mm | 0.08in | 21.92 | 2653 |
| m0781 | i0031 | 781mm | 30.76in | 769mm | 30.28in | 2mm | 0.08in | 23.08 | 2792 |
| m0820 | i0032 | 820mm | 32.27in | 808mm | 31.80in | 2mm | 0.08in | 24.23 | 2932 |
| m0858 | i0034 | 858mm | 33.79in | 846mm | 33.31in | 2mm | 0.08in | 25.38 | 3072 |
| m0897 | i0035 | 897mm | 35.30in | 885mm | 34.83in | 2mm | 0.08in | 26.54 | 3211 |
| m0935 | i0037 | 935mm | 36.81in | 923mm | 36.34in | 2mm | 0.08in | 27.69 | 3351 |
| m0974 | i0038 | 974mm | 38.33in | 962mm | 37.86in | 2mm | 0.08in | 28.85 | 3490 |
| m1012 | i0040 | 1012mm | 39.84in | 1000mm | 39.37in | 2mm | 0.08in | 30.00 | 3630 |

¹ Actual total overall length of light fixture (LED strip + end caps + void/wire hole)

² Actual length of PCB strip

³ Actual length of 2x end caps

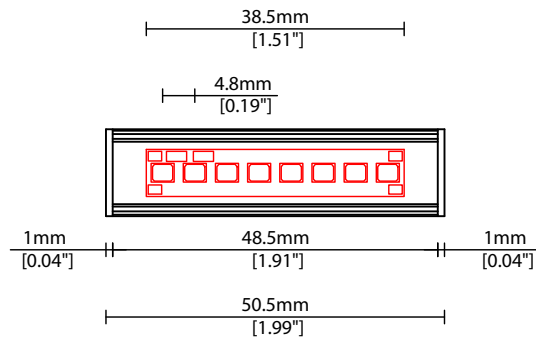

Linear

TIMI Asymmetric AS30 (30W) Options

KKDC

COVER/LENS OPTIONS

* Options are an integral part of the fixture ordering codes. Please refer to **Code Table** pages.

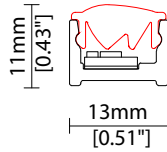

A2 KKLN-A2 Asymmetric
H11/W13 (H0.43/W0.51")

FIXING OPTIONS

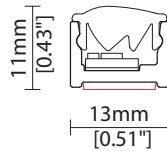
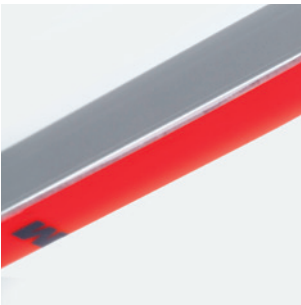

TF Tape fixing

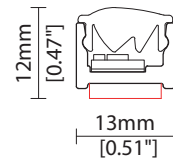

MF Magnet fixing

POWER FEED OPTIONS

0300 S00X 300mm (11.81") Single no sheath tail

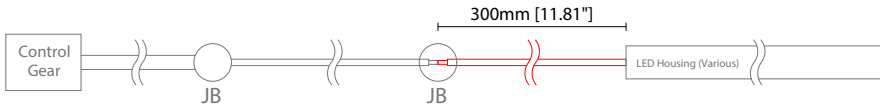

0300 D00X 300mm (11.81") Double no sheath tail

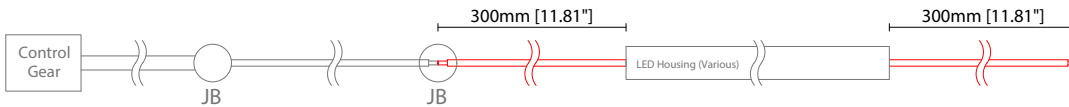

0300 S20X 300mm (11.81") Single no sheath IP20 connector

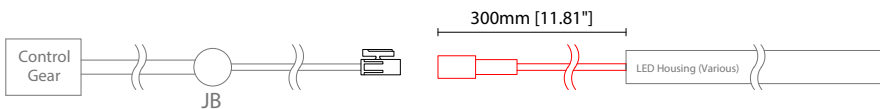

0300 D20X 300mm (11.81") Double no sheath IP20 connector

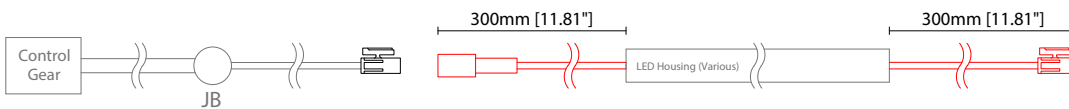

2 Pin Female Connector

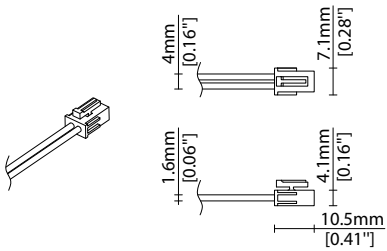

2 Pin Male Connector

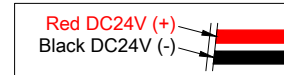
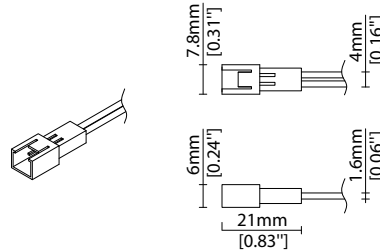

Key

- Control Gear Power supply, sub-controllers & control systems
- JB Junction box / cable connection

POWER FEED

Note: Accessories are to be ordered separately with corresponding code shown below.

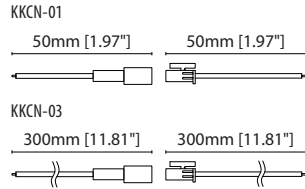
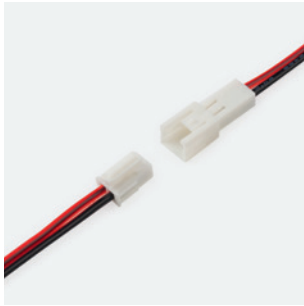

KKCN-01 50mm (1.97in) pair
KKCN-03 300mm (11.81in) pair
 2 PIN male + female connector set

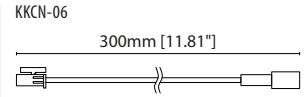

KKCN-06
 2 PIN 300mm (11.81in) extension lead

KKDC CONTROL



IP20
 Plastic housing
 L170/W59/H29mm
 (L6.69/W2.32/H1.14in)

KKDM-06 1-10V
 visDIM dimmable sub-controller
 (4 x 8A max @ 12-36V)



IP20
 Plastic housing
 L170/W53.4/H28mm
 (L6.69/W2.10/H1.10in)

KKSC-05 DMX
 visDIM dimmable sub-controller
 (4 x 5A max @ 12-36V)



IP20
 Plastic housing
 L170/W59/H29mm
 (L6.69/W2.32/H1.14in)

KKDL-02 DALI
 visDIM dimmable sub-controller
 (4 x 8A max @ 12-36V)



IP20
 Plastic housing
 L166/W53.4/H23mm
 (L6.54/W2.10/H0.91in)

KKDL-03 DALI
 visDIM dimmable sub-controller
 (4 x 5A max @ 12-36V)

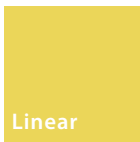

TIMI

Driver/PSU Options



AVAILABLE PSU OPTIONS

| Control Mode | PSU (Order Code) | Input Voltage AC | Output Voltage DC | Rated Output Current | Rated Power | Dim % | IP Rating |
|---------------|------------------|------------------|-------------------|----------------------|-------------|-------------------|-----------|
| Switched | CEN-60-24 | 90-295V | 24V | 2.5A | 60W | - | IP67 |
| | HLG-60H-24 | 90-305V | 24V | 2.5A | 60W | - | IP67 |
| | HLG-100H-24 | 90-305V | 24V | 4.0A | 100W | - | IP67 |
| | HLG-150H-24 | 90-305V | 24V | 6.3A | 150W | - | IP67 |
| | HLG-240H-24 | 90-305V | 24V | 10A | 240W | - | IP67 |
| 0-10V (1-10V) | PWM-40-24 | 90-305V | 24V | 1.67A | 40W | 100-0.15 (100-10) | IP67 |
| | PWM-60-24 | 90-305V | 24V | 2.5A | 60W | 100-0.15 (100-10) | IP67 |
| | PWM-90-24 | 90-305V | 24V | 3.67A | 90W | 100-0.15 (100-10) | IP67 |
| | PWM-120-24 | 90-305V | 24V | 5.0A | 120W | 100-0.15 (100-10) | IP67 |
| DALI | LIN100A1 | 120-277V | 24V | 1A per channel | 100W | 100-0.1 | IP66/IP40 |
| DMX RGB | LIN100A1 | 120-277V | 24V | 1.33A per channel | 100W | 100-0.1 | IP66/IP40 |
| DMX RGBW | LIN100A1 | 120-277A | 24V | 1A per channel | 100W | 100-0.1 | IP66/IP40 |

Flicker Free Options - Combination of PSU+ sub-controller

| Control Mode | PSU (Order Code) | Sub-controller (Order Code) | Input Voltage AC | Output Voltage DC | Rated Output Current | Rated Power | Dim % | IP Rating PSU/ Sub-controller |
|----------------|------------------|-----------------------------|------------------|-------------------|----------------------|-------------|---------|-------------------------------|
| 0-10V or 1-10V | CEN-60-24 | KKDM-06 | 90-295V | 24V | 2.5A | 60W | 100-0.9 | IP67/IP20 |
| | HLG-60H-24 | KKDM-06 | 90-295V | 24V | 2.5A | 60W | 100-0.9 | IP67/IP20 |
| | HLG-100H-24 | KKDM-06 | 90-295V | 24V | 4.0A | 100W | 100-0.9 | IP67/IP20 |
| | HLG-150H-24 | KKDM-06 | 90-295V | 24V | 6.3A | 150W | 100-0.9 | IP67/IP20 |
| | HLG-240H-24 | KKDM-06 | 90-295V | 24V | 10.0A | 240W | 100-0.9 | IP67/IP20 |
| DALI | CEN-60-24 | KKDL-02/03 | 90-295V | 24V | 2.5A | 60W | 100-0.1 | IP67/IP20 |
| | HLG-60H-24 | KKDL-02/03 | 90-305V | 24V | 2.5A | 60W | 100-0.1 | IP67/IP20 |
| | HLG-100H-24 | KKDL-02/03 | 90-305V | 24V | 4.0A | 100W | 100-0.1 | IP67/IP20 |
| | HLG-150H-24 | KKDL-02/03 | 90-305V | 24V | 6.3A | 150W | 100-0.1 | IP67/IP20 |
| | HLG-240H-24 | KKDL-02/03 | 90-305V | 24V | 10.0A | 240W | 100-0.1 | IP67/IP20 |
| DMX RGB | CEN-60-24 | KKSC-05 | 90-295V | 24V | 2.5A | 60W | 100-0.9 | IP67/IP20 |
| | HLG-60H-24 | KKSC-05 | 90-305V | 24V | 2.5A | 60W | 100-0.9 | IP67/IP20 |
| | HLG-100H-24 | KKSC-05 | 90-305V | 24V | 4A | 100W | 100-0.9 | IP67/IP20 |
| | HLG-150H-24 | KKSC-05 | 90-305V | 24V | 6.3A | 150W | 100-0.9 | IP67/IP20 |
| | HLG-240H-24 | KKSC-05 | 90-305V | 24V | 10.0A | 240W | 100-0.9 | IP67/IP20 |

¹ The items shown above cover the most frequently used specification but does not exhaust the possible options

² PSU and/or driver can be chosen from the table, or KKDC may recommend the best option upon receipt of the controls requirement and installation environment

³ Electrical shop drawing will include detailed information of PSU and relevant control drivers

⁴ Cut sheets are available on the controls section of www.kkdc.lighting or upon request